



MSG[®] Centac[®] Centrifugal Air Compressors

175-6,000 hp (130-4,500 kW)



A Tradition of Proven Reliability, Efficiency and Productivity

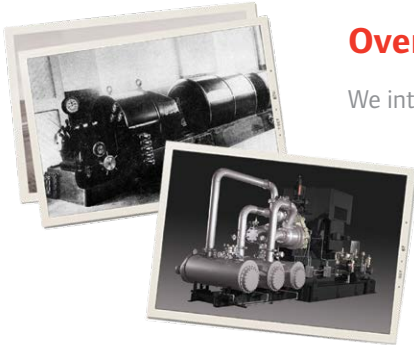

Over 100 years of Oil-Free Innovation

We introduced our first oil-free centrifugal compressor in 1912, and over the decades we've continued to develop rugged, reliable, industry-leading compressor technologies. Ingersoll Rand has become the leader in oil-free centrifugal compressed air because our technological advances are designed for the specific performance needs of our customers' industries.

No matter what the application, Ingersoll Rand centrifugal compressors help eliminate inefficiencies, contaminants and breakdowns that can result in costly downtime, product liability or damage to your brand reputation, while reducing total lifecycle costs.

RELIABILITY

Superior Design, Superior Life

- Fewer moving parts means less downtime
- Dynamically balanced rotor assemblies ensure extremely low vibration
- Carbon ring seals minimize air leakage

Lowers cost of ownership

EFFICIENCY

Optimized Components and Systems

- Multi-stage compressors combine performance with energy savings
- Advanced impeller design provides maximum pressure control over the widest operating range

Reduces energy use and operating costs

PRODUCTIVITY

User-Friendly Operation and Accessibility

- Easy-access components make maintenance faster and easier
- Simplified compressor design provides longer intervals between maintenance

Maximizes uptime

MSG® Centac® C800

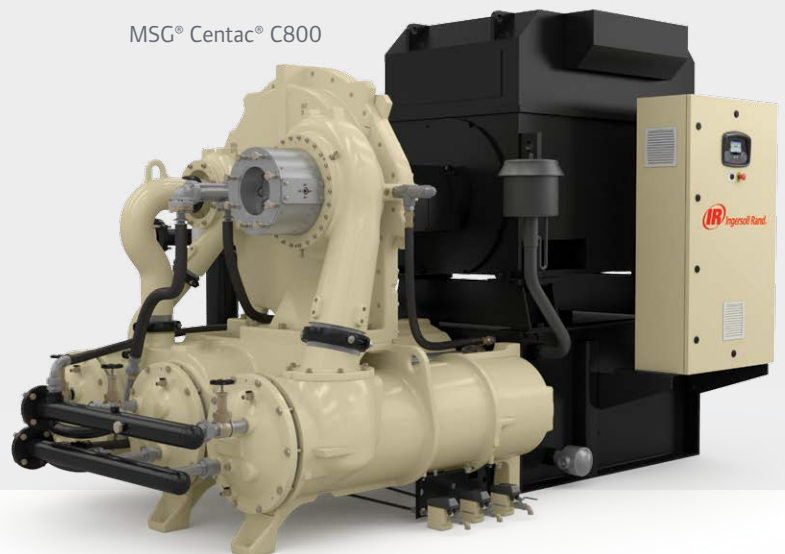

The Centrifugal Technology Your Industry Demands



Oil-Free, Risk Free

The first to be certified ISO 8573-1:2001 Class 0, our oil-free centrifugal compressors offer efficient, economical and reliable solutions for delivering compressed air. These high-performing, versatile compressors provide 100% oil-free air in all operating conditions.

ISO 8573 **Class 0**
Oil-Free Air



MSG Centac C3000

Greater Capacity for Greater Efficiency

Ingersoll Rand centrifugal compressors offer up to a 15% capacity advantage over competitive two-stage, oil-free compressors. This advantage increases to as much as 30% as our capacity remains constant, while competitive capacities decrease by up to 15%.

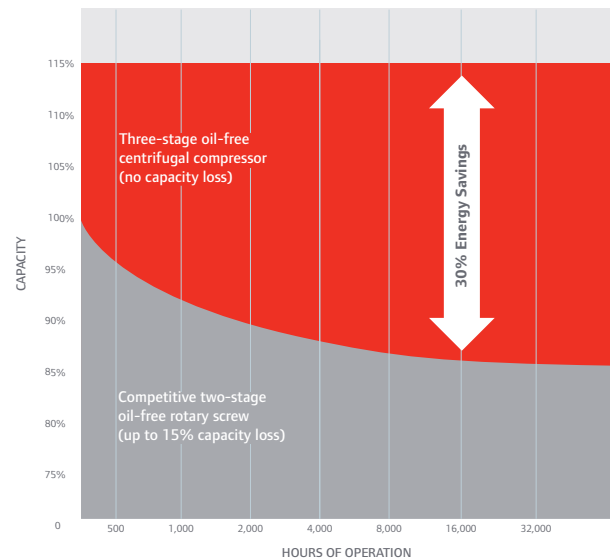

MSG Centac...Engineered for Performance

Ingersoll Rand centrifugal compressors are designed for applications where reliability, productivity and efficiency are essential to getting the job done right...and the compressor's packaged design makes it easy to install wherever needed.

Long-Life Gears

25-year rated, uniformly hardened gears provide extreme reliability

Efficient Impeller Design

Backward leaning impellers provide constant pressure control while maximizing efficiency and turndown range

Moisture Separator

Stainless steel moisture separator provides superior reliability and helps prevent corrosion, ensuring high air quality

Coolers

Precisely engineered coolers maintain a low pressure drop and the large surface area provides maximum cooling efficiency. The integral cooler design helps the compressor keep a compact footprint*

*Optional external configurations available

High Capacity Bearings

Hydrodynamic bearings are completely non-contact, offering virtually unlimited life and maximum efficiency with 2-3 times the lifespan of traditional bearings

Rotors

High grade steel rotors are fully balanced and require no coating, providing constant performance over time

Seals

Fully floating, non-contact carbon ring seals minimize air leakage and prevent oil from migrating into the compressed air stream; single-piece seal construction provides significantly better performance than other technologies, saving valuable compressed air

Diffuser

Optimally designed to work with Ingersoll Rand's backward leaning impellers for maximum efficiency

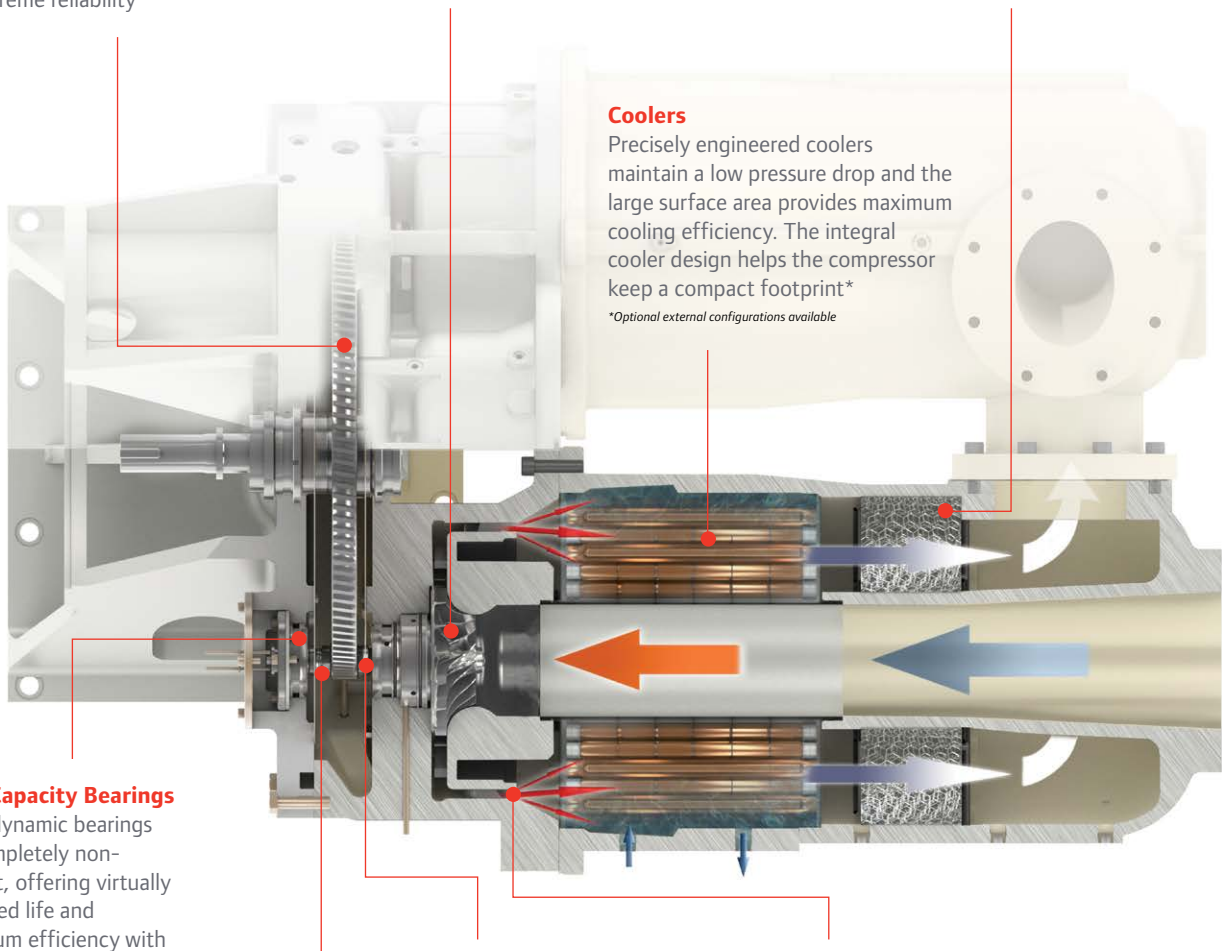

Advanced Centrifugal Control

Optimize Your Compressed Air System with Xe-Series Controls

The Ingersoll Rand Xe-Series controller uses the latest control algorithms to help lower energy consumption. Built-in control logic ensures system reliability by precisely managing discharge pressure and maximizing throttle range. The controller's intuitive, high-resolution color display makes critical information quick and easy to find. And with web-enabled alerts, the Xe-Series controller helps you maintain optimal operation automatically.



Web-Enabled Communication

- Start/stop/load/unload and checks parameters remotely
- Email notification of alarms and trips
- Built-in performance reporting and visual trending with automated inspection logs



More Connectivity Choices

- Communicates directly with your DCS system through Modbus
- Ethernet connection enables communication and control through tablets, computers or mobile devices
- Connects seamlessly with Ingersoll Rand system controls
- Sequences up to four additional controlled compressors with no additional hardware

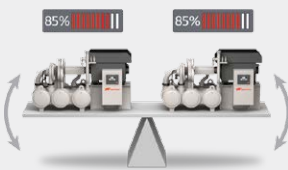

Intelligent Compressor Control

- Constant Pressure Control-Continually maintains precise discharge pressure to adjust for sudden demand variations
- Auto Dual Control-Provides enhanced energy savings during partial load conditions
- Energy Smart Set Point (ESS)-Adjusts settings to balance and share loads between multiple compressors in the same system, reducing bypassed air and saving energy

We Build Solutions

We do more than build products at Ingersoll Rand. We bring our customers unmatched experience in designing comprehensive compressed air systems that cover virtually any need.

Systems and Support to Keep You Productive

Ingersoll Rand not only designs and builds extremely efficient air systems, it solves process and business problems as well. This helps customers succeed in today's global economy through enhanced reliability, energy efficiency and productivity.

No matter what your industry or location, Ingersoll Rand is committed to serving you 24/7. Our worldwide network of distributors, engineers and certified, factory-trained technicians are a phone call away—ready to support you with innovative, cost-effective and performance-enhancing solutions.

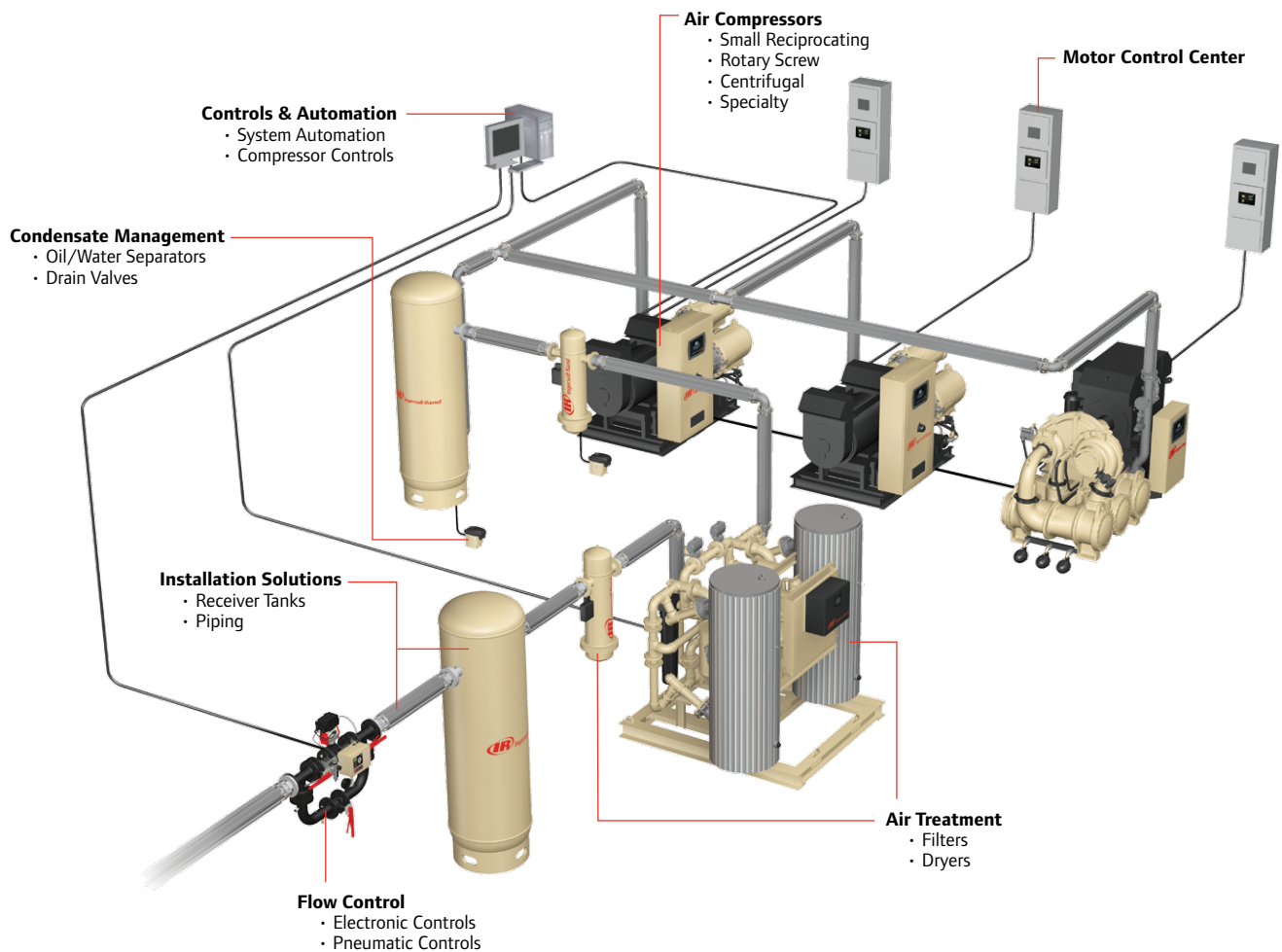

Low Pressure						
Model	Pressure		Flow		Power	
	psi	cfm	m ³ /min	hp	kW	
CH5	15-30	1,500-3,000	42-80	175-350	130-270	
CH6	15-30	3,200-6,000	90-160	225-600	170-430	
Standard Pressure						
Model	Pressure		Flow		Power	
	psi	cfm	m ³ /min	hp	kW	
C400	90-125	1,600-2,300	45-65	375-525	275-425	
C700	45-150	1,900-4,000	55-115	350-900	270-700	
C800	45-190	2,300-5,300	65-150	450-1,300	350-950	
C950	45-150	4,200-6,000	120-170	500-1,500	375-1,100	
C1000	45-150	4,700-7,800	135-220	800-1,750	600-1,300	
3CII	45-150	6,000-9,000	170-255	1,150-2,500	850-1,900	
C3000	45-150	9,500-15,000	270-450	1,600-3,500	1,200-2,600	
5CII	45-150	12,000-28,000	350-800	2,400-6,000	1,800-4,500	
High Pressure						
Model	Pressure		Flow		Power	
	psi	cfm	m ³ /min	hp	kW	
2CII	160-350	3,200-5,000	90-140	1,000-1,750	800-1,200	
C750	440-610	1,800-2,100	50-60	875-1,000	650-750	
C1050	610	4,000	115	1,500	1,150	
3C	160-350	6,000-9,000	170-255	800-2,700	600-2,000	
4C	160-350	9,000-15,000	255-425	1,475-4,500	1,100-3,400	

Please contact Ingersoll Rand for specific data.

Your Trusted Partner in Compressed Air

Ingersoll Rand products and services optimize total Cost of ownership, while maximizing Availability, Reliability and Efficiency for the entire lifecycle of your system.

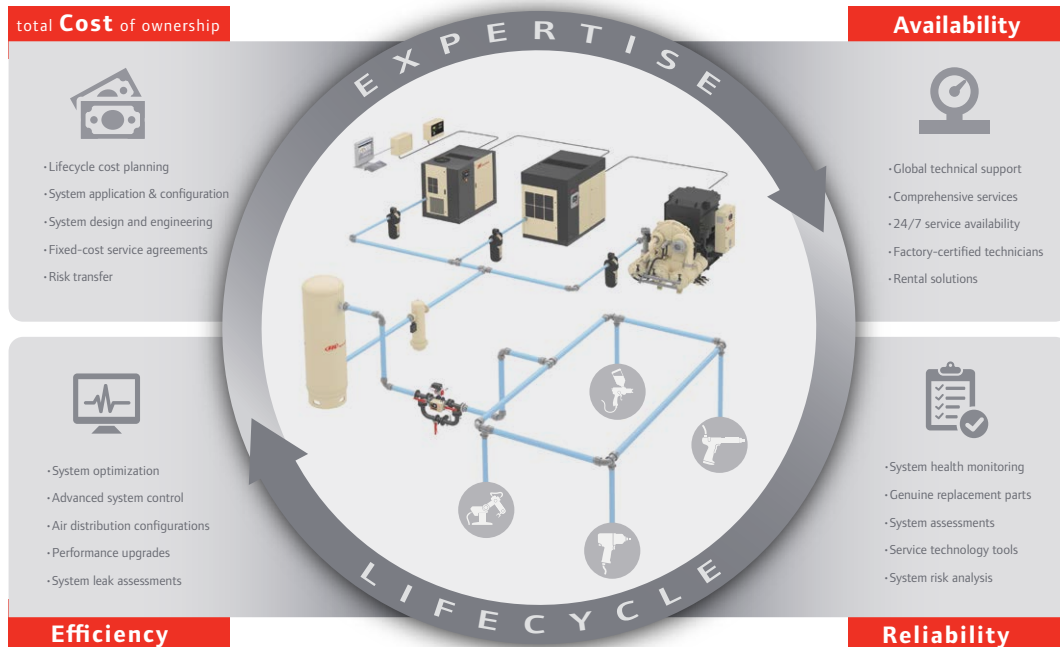

Design • Install • Commission • Operate • Maintain • Extend



Ingersoll Rand (NYSE:IR) advances the quality of life by creating comfortable, sustainable and efficient environments. Our people and our family of brands—including Club Car®, Ingersoll Rand®, Thermo King® and Trane®—work together to enhance the quality and comfort of air in homes and buildings; transport and protect food and perishables; and increase industrial productivity and efficiency. We are a \$13 billion global business committed to a world of sustainable progress and enduring results.



IngersollRandProducts.com



Member of Pneurop



Ingersoll Rand, IR, the IR Logo and MSC Centac are trademarks of Ingersoll Rand, its subsidiaries and/or affiliates. All other trademarks are the property of their respective owners.

Ingersoll Rand compressors are not designed, intended or approved for breathing air applications. Ingersoll Rand does not approve specialized equipment for breathing air applications and assumes no responsibility or liability for compressors used for breathing air service.

Nothing contained on these pages is intended to extend any warranty or representation, expressed or implied, regarding the product described herein. Any such warranties or other terms and conditions of sale of products shall be in accordance with Ingersoll Rand's standard terms and conditions of sale for such products, which are available upon request.

Product improvement is a continuing goal at Ingersoll Rand. Any designs, diagrams, pictures, photographs and specifications contained within this document are for representative purposes only and may include optional scope and/or functionality and are subject to change without notice or obligation.